

# LTC 8785 Series



Security Systems

EN | Instruction Manual  
Code Converter Units

# BOSCH

## Important Safeguards

1. **Read, Follow, and Retain Instructions** - All safety and operating instructions should be read and followed before operating the unit. Retain instructions for future reference.
2. **Heed Warnings** - Adhere to all warnings on the unit and in the operating instructions.
3. **Attachments** - Attachments not recommended by the product manufacturer should not be used, as they may cause hazards.
4. **Installation Cautions** - Do not place this unit on an unstable stand, tripod, bracket, or mount. The unit may fall, causing serious injury to a person and serious damage to the unit. Use only manufacturer-recommended accessories, or those sold with the product. Mount the unit per the manufacturer's instructions. Appliance and cart combination should be moved with care. Quick stops, excessive force, or uneven surfaces may cause the appliance and cart combination to overturn.
5. **Cleaning** - Unplug the unit from the outlet before cleaning. Follow any instructions provided with the unit. Generally, using a damp cloth for cleaning is sufficient. Do not use liquid cleaners or aerosol cleaners.
6. **Servicing** - Do not attempt to service this unit yourself. Opening or removing covers may expose you to dangerous voltage or other hazards. Refer all servicing to qualified service personnel.
7. **Damage Requiring Service** - Unplug the unit from the main AC power source and refer servicing to qualified service personnel under the following conditions:
  - When the power supply cord or plug is damaged.
  - If liquid has been spilled or an object has fallen into the unit.
  - If the unit has been exposed to water and/or inclement weather (rain, snow, etc.).
  - If the unit does not operate normally, when following the operating instructions. Adjust only those controls specified in the operating instructions. Improper adjustment of other controls may result in damage, and require extensive work by a qualified technician to restore the unit to normal operation.
  - If the unit has been dropped or the cabinet damaged.
  - If the unit exhibits a distinct change in performance, this indicates that service is needed.
8. **Replacement Parts** - When replacement parts are required, the service technician should use replacement parts specified by the manufacturer or that have the same characteristics as the original part. Unauthorized substitutions may result in fire, electrical shock or other hazards.
9. **Safety Check** - Upon completion of servicing or repairs to the unit, ask the service technician to perform safety checks to ensure proper operating condition.
10. **Power Sources** - Operate the unit only from the type of power source indicated on the label. If unsure of the type of power supply to use, contact your dealer or local power company.
  - For units intended to operate from battery power, refer to the operating instructions.
  - For units intended to operate **with External Power Supplies**, use only the recommended approved power supplies.
  - For units intended to operate with a limited power source, this power source must comply with EN60950. Substitutions may damage the unit or cause fire or shock.
  - For units intended to operate at 24VAC, normal input voltage is **24 VAC**. Voltage applied to the unit's power input should not exceed 30VAC. User-supplied wiring, from the 24VAC supply to unit, must be in compliance with electrical codes (Class 2 power levels). Do not ground the 24VAC supply at the terminals or at the unit's power supply terminals.
11. **Coax Grounding** - If an outside cable system is connected to the unit, ensure that the cable system is grounded. U.S.A. models only - Section 810 of the National Electrical Code, ANSI/NFPA No.70, provides information regarding proper grounding of the mount and supporting structure, grounding of the coax to a discharge unit, size of grounding conductors, location of discharge unit, connection to grounding electrodes, and requirements for the grounding electrode.
12. **Grounding or Polarization** - This unit may be equipped with a polarized alternating current line plug (a plug with one blade wider than the other). This safety feature allows the plug to fit into the power outlet in only one way. If unable to insert the plug fully into the outlet, try reversing the plug. If the plug still fails to fit, contact an electrician to arrange replacement of the obsolete outlet. Do not defeat the safety purpose of the polarized plug. Alternately, this unit may be equipped with a 3-wire grounding plug (a plug with a third pin, for grounding). This safety feature allows the plug to fit into a grounding power outlet only. If unable to insert the plug into the outlet, contact an electrician to arrange replacement of the obsolete outlet. Do not defeat the safety purpose of the grounding plug.
13. **Lightning** - For added protection during a lightning storm, or when this unit is left unattended and unused for long periods of time, unplug the unit from the wall outlet and disconnect the cable system. This will prevent damage to the unit due to lightning and power line surges.

### For Indoor Product

1. **Water and Moisture** - Do not use this unit near water - for example, in a wet basement, in an unprotected outdoor installation or in any area classified as a wet location.
2. **Object and Liquid Entry** - Never push objects of any kind into this unit through openings, as they may touch dangerous voltage points or short out parts that could result in a fire or electrical shock. Never spill liquid of any kind on the unit.
3. **Power Cord and Power Cord Protection** - For units intended to operate with 230VAC, 50Hz, the input and output power cord must comply with the latest versions of IEC Publication 227 or IEC Publication 245.  
Power supply cords should be routed so they are not likely to be walked on or pinched. Pay particular attention to location of cords and plugs, convenience receptacles, and the point of exit from the appliance.
4. **Overloading** - Do not overload outlets and extension cords; this can result in a risk of fire or electrical shock.

### For Outdoor Product

**Power Lines** - An outdoor system should not be located in the vicinity of overhead power lines, electric lights or power circuits, or where it may contact such power lines or circuits. When installing an outdoor system, extreme care should be taken to keep from touching power lines or circuits, as this contact might be fatal. U.S.A. models only - refer to the National Electrical Code Article 820 regarding installation of CATV systems.

### For Rack-mount Product

1. **Ventilation** - This unit should not be placed in a built-in installation or rack, unless proper ventilation is provided, or the manufacturer's instructions have been adhered to. The equipment must not exceed its maximum operating temperature requirements.
2. **Mechanical Loading** - Mounting of the equipment in a rack shall be such that a hazardous condition is not achieved due to uneven mechanical loading.

## Safety Precautions



### CAUTION

RISK OF ELECTRIC SHOCK. DO NOT OPEN!



**CAUTION: TO REDUCE THE RISK OF ELECTRIC SHOCK, DO NOT REMOVE COVER (OR BACK). NO USER SERVICEABLE PARTS INSIDE. REFER SERVICING TO QUALIFIED SERVICE PERSONNEL.**



This symbol indicates the presence of uninsulated "dangerous voltage" within the product's enclosure. This may constitute a risk of electric shock.



The user should consult the operating and maintenance (servicing) instructions in the literature accompanying the appliance.



Attention: Installation should be performed by qualified service personnel only in accordance with the National Electrical Code or applicable local codes.



**Power Disconnect.** Units with or without ON-OFF switches have power supplied to the unit whenever the power cord is inserted into the power source; however, the unit is operational only when the ON-OFF switch is in the ON position. The power cord is the main power disconnect for all units.



**ATTENTION**  
OBSERVE PRECAUTIONS  
FOR HANDLING  
ELECTROSTATIC SENSITIVE  
DEVICES

### WARNING:

Electrostatic-sensitive device. Use proper CMOS/MOSFET handling precautions to avoid electrostatic discharge.

**NOTE:** Grounded wrist straps must be worn and proper ESD safety precautions observed when handling the electrostatic-sensitive printed circuit boards.

## FCC & ICES INFORMATION

### (U.S.A. and Canadian Models Only)

This device complies with part 15 of the FCC Rules. Operation is subject to the following two conditions:







- (1) This device may not cause harmful interference, and
- (2) This device must accept any interference received, including interference that may cause undesired operation.

**NOTE:** This equipment has been tested and found to comply with the limits for a Class B digital device, pursuant to Part 15 of the FCC Rules and ICES-003 of Industry Canada. These limits are designed to provide reasonable protection against harmful interference when the equipment is operated in a residential installation. This equipment generates, uses and can radiate radio frequency energy, and if not installed and used in accordance with the instructions, may cause harmful interference to radio communications. However, there is no guarantee that interference will not occur in a particular installation. If this equipment does cause harmful interference to radio or television reception, which can be determined by turning the equipment off and on, the user is encouraged to try to correct the interference by one or more of the following measures:





- Reorient or relocate the receiving antenna.
- Increase the separation between the equipment and receiver.
- Connect the equipment into an outlet on a circuit different from that to which the receiver is connected.
- Consult the dealer, or an experienced radio/TV technician for help.

Intentional or unintentional changes or modifications, not expressly approved by the party responsible for compliance, shall not be made. Any such changes or modifications could void the user's authority to operate the equipment. The user may find the following booklet, prepared by the Federal Communications Commission, helpful: [How to Identify and Resolve Radio-TV Interference Problems](#). This booklet is available from the U.S. Government Printing Office, Washington, DC 20402, Stock No. 004-000-00345-4.







## Sécurité

	<b>ATTENTION</b> RISQUE D'ÉLECTROCUTION. NE PAS OUVRIR !	
<p><b>ATTENTION : POUR ÉVITER TOUT RISQUE D'ÉLECTROCUTION, N'ESSAYEZ PAS DE RETIRER LE CAPOT (OU LE PANNEAU ARRIÈRE). CET APPAREIL NE CONTIENT AUCUN COMPOSANT SUSCEPTIBLE D'ÊTRE RÉPARÉ PAR L'UTILISATEUR. CONFIEZ LA RÉPARATION DE L'APPAREIL À DU PERSONNEL QUALIFIÉ.</b></p>		
	<p>Ce symbole signale que le produit renferme une « tension potentiellement dangereuse » non isolée susceptible de provoquer une électrocution.</p>	
	<p>Ce symbole invite l'utilisateur à consulter les instructions d'utilisation et d'entretien (dépannage) reprises dans la documentation qui accompagne l'appareil.</p>	
	<p>Attention : l'installation doit exclusivement être réalisée par du personnel qualifié, conformément au code national d'électricité américain (NEC) ou au code d'électricité local en vigueur.</p>	
	<p>Coupage de l'alimentation. Qu'ils soient pourvus ou non d'un commutateur ON/OFF, tous les appareils reçoivent de l'énergie une fois le cordon branché sur la source d'alimentation. Toutefois, l'appareil ne fonctionne réellement que lorsque le commutateur est réglé sur ON. Le débranchement du cordon d'alimentation permet de couper l'alimentation des appareils.</p>	

## Sicherheitshinweise

	<b>VORSICHT</b> ELEKTRISCHE SPANNUNG. NICHT ÖFFNEN!	
<p><b>VORSICHT: UM EINEN ELEKTRISCHEN SCHLAG ZU VERMEIDEN, IST DIE ABDECKUNG (ODER RÜCKSEITE) NICHT ZU ENTFERNEN. ES BEFINDEN SICH KEINE TEILE IN DIESEM BEREICH, DIE VOM BENUTZER GEWARTET WERDEN KÖNNEN. LASSEN SIE WARTUNGSARBEITEN NUR VON QUALIFIZIERTEM WARTUNGSPERSONAL AUSFÜHREN.</b></p>		
	<p>Das Symbol macht auf nicht isolierte „gefährliche Spannung“ im Gehäuse aufmerksam. Dies kann zu einem elektrischen Schlag führen.</p>	
	<p>Der Benutzer sollte sich ausführlich über Anweisungen für die Bedienung und Instandhaltung (Wartung) in den begleitenden Unterlagen informieren.</p>	
	<p>Achtung! Die Installation sollte nur von qualifiziertem Kundendienstpersonal gemäß jeweils zutreffender Elektrovorschriften ausgeführt werden.</p>	
	<p>Unterbrechung des Netzanschlusses. Geräte mit oder ohne Netzschalter haben Spannung am Gerät anliegen, sobald der Netzstecker in die Steckdose gesteckt wird. Das Gerät ist jedoch nur betriebsbereit, wenn der Netzschalter (EIN/AUS) auf EIN steht. Wenn das Netzkabel aus der Steckdose gezogen wird, ist die Spannungszuführung zum Gerät vollkommen unterbrochen.</p>	

## Precauciones de Seguridad

	<b>ATTENZIONE</b> PERICOLO DI SCOSSA ELETTRICA. NON APRIRE.	
<p><b>PRECAUCIÓN: PARA DISMINUIR EL RIESGO DE DESCARGA ELÉCTRICA, NO RETIRE LA CUBIERTA (NI LA PARTE POSTERIOR). NO EXISTEN PIEZAS DE RECAMBIO EN EL INTERIOR DEL EQUIPO. EL PERSONAL DE SERVICIO CUALIFICADO SE ENCARGA DE REALIZAR LAS REPARACIONES.</b></p>		
	<p>Este símbolo indica que existen puntos de tensión peligrosos sin aislamiento dentro de la cubierta de la unidad. Estos puntos pueden constituir un riesgo de descarga eléctrica.</p>	
	<p>El usuario debe consultar las instrucciones de funcionamiento y mantenimiento (reparación) en la documentación que se suministra con el aparato.</p>	
	<p>Atención: la instalación la debe realizar únicamente personal cualificado de conformidad con el National Electric Code o las normas aplicables en su país.</p>	
	<p>Desconexión de la alimentación. Las unidades con o sin interruptores de encendido/apagado reciben alimentación eléctrica siempre que el cable de alimentación esté conectado a la fuente de alimentación. Sin embargo, la unidad sólo funciona cuando el interruptor está en la posición de encendido. El cable de alimentación es la principal fuente de desconexión de todas las unidades.</p>	







## Veiligheidsmaatregelen

	<b>VOORZICHTIG</b> GEVAARVOOR ELEKTRISCHE SCHOK. NIET OPENEN!	
<p><b>VOORZICHTIG: OPEN DE BEHUIZING OF DE ACHTERKANT VAN HET APPARAAT NIET. ZO VERMINDERT U HET RISICO OP ELEKTRISCHE SCHOKKEN. IN HET APPARAAT BEVINDEN ZICH GEEN ONDERDELEN DIE U ZELF KUNT REPAREREN. LAAT SERVICE EN ONDERHOUD UITVOEREN DOOR GEKWALIFICEERD PERSONEEL.</b></p>		
	Dit symbool geeft aan dat er binnen in het apparaat ongeïsoleerde, gevaarlijke spanning aanwezig is die mogelijk elektrische schokken kan veroorzaken.	
	De gebruiker dient de bedienings- en onderhoudsvoorschriften te raadplegen in de documentatie die werd meegeleverd met het apparaat.	
	Attentie: het apparaat mag alleen door gekwalificeerd personeel worden geïnstalleerd. De installatie dient in overeenstemming met de nationale elektrische richtlijnen of de van toepassing zijnde lokale richtlijnen te worden uitgevoerd.	
	Spanning uitschakelen. Apparatuur met of zonder aan-uitschakelaar staat onder spanning zolang de stekker is aangesloten op de wandcontactdoos. De apparatuur is uitsluitend in werking als de aan-uitschakelaar aan staat. Het netsnoer is de "hoofdschakelaar" voor alle apparatuur.	

## Sicurezza

	<b>ATTENZIONE</b> PERICOLO DI SCOSSA ELETTRICA. NON APRIRE.	
<p><b>ATTENZIONE: PER RIDURRE IL RISCHIO DI SCOSSE ELETTRICHE NON RIMUOVERE LA COPERTURA (O IL PANNELLO POSTERIORE). L'UNITÀ NON CONTIENE COMPONENTI INTERNI RIPARABILI DALL'UTENTE. PER QUALSIASI INTERVENTO, RIVOLGERSI A PERSONALE TECNICO QUALIFICATO.</b></p>		
	Questo simbolo indica la presenza di "tensione pericolosa" non isolata all'interno del contenitore del prodotto. Ciò comporta un potenziale rischio di scosse elettriche.	
	Si consiglia di consultare le istruzioni operative e di manutenzione (interventi tecnici) contenute nella documentazione fornita con il dispositivo.	
	Attentive: l'installazione deve essere effettuata esclusivamente da personale tecnico qualificato in conformità con il National Electrical Code o con le normative locali vigenti.	
	Scollegamento dell'alimentazione. Le unità dotate o sprovviste di interruttori ON-OFF vengono alimentate quando si inserisce il cavo nella presa dell'alimentazione. L'unità è tuttavia in funzione solo quando l'interruttore ON-OFF si trova nella posizione ON. Il cavo di alimentazione costituisce il dispositivo di scollegamento dell'alimentazione principale per tutte le unità.	

## Medidas de Segurança

	<b>CUIDADO</b> RISCO DE CHOQUE ELÉTRICO. NÃO ABRIR!	
<p><b>CUIDADO: PARA REDUZIR O RISCO DE CHOQUE ELÉTRICO, NÃO RETIRE A TAMPA (OU A PARTE POSTERIOR). NO INTERIOR, NÃO EXISTEM PEÇAS QUE POSSAM SER REPARADAS PELO UTILIZADOR. REMETA A ASSISTÊNCIA PARA OS TÉCNICOS QUALIFICADOS.</b></p>		
	Este símbolo indica a presença de "tensão perigosa" não isolada dentro da estrutura do produto, o que pode constituir risco de choque eléctrico.	
	O utilizador deve consultar as instruções de funcionamento e manutenção (assistência) nos documentos que acompanham o aparelho.	
	Atenção: a instalação deve ser executada apenas por técnicos qualificados da assistência, de acordo com o código eléctrico nacional ou os códigos locais aplicáveis.	
	Corte de corrente. As unidades com ou sem interruptores ON-OFF (ligar/desligar) recebem corrente sempre que o fio de alimentação está introduzido na fonte de alimentação; contudo, a unidade apenas está operacional quando o interruptor ON-OFF está na posição ON. O fio de alimentação destina-se a desligar a corrente em todas as unidades.	

## 安全预防措施

	<b>CAUTION</b> RISK OF ELECTRIC SHOCK. DO NOT OPEN!	
<p><b>注意：为避免受到电击，不要拆除机盖（或后盖）。用户不得擅自维修里面的部件。有关维修事项，请咨询合格的维修人员。</b></p>		
	此符号表示产品机壳内存在未绝缘的“危险电压”。这可能导致电击。	
	用户应参照设备附带的操作和维护（维修）说明。	
	注意：安装须由合格的维修人员遵照美国国家电工标准或相关电气规则进行。	
	断开电源。在电源线插入电源时，配备或未配备 ON-OFF 开关的设备都已通电；但设备只有在 ON-OFF 开关处于 ON 位置时才能工作。对于所有设备，电源线是断开电源的主要方式。	

## Table of Contents

Important Safeguards .....	2
FCC Information .....	4
1 UNPACKING .....	7
2 SERVICE .....	7
3 DESCRIPTION .....	7
4 INSTALLATION .....	8
4.1 Power .....	8
4.2 Procedure .....	8
4.3 Cover Removal .....	8
4.4 Mounting Options .....	8
5 OPERATION .....	9
6 ILLUSTRATIONS .....	9

## 1 UNPACKING

Unpack carefully. This is electronic equipment and should be handled carefully.

Check for the following items:

- Verify the model number of the unit
- One (1) cable with 9-pin D-sub connectors
- Connector Kit, containing eight (8) pieces of a twelve (12) pin connector
- Installation manual

If an item appears to have been damaged in shipment, replace it properly in its carton and notify the shipper. If any items are missing, notify your Bosch Security Systems, Inc. Sales Representative or Customer Service.

The shipping carton is the safest container in which the unit may be transported. Save it for possible future use.

## 2 SERVICE

If the unit ever needs repair service, the customer should contact the nearest Bosch Security Systems, Inc. Service Center for return authorization and shipping instructions.

### Service Centers

#### USA

Phone: 800-366-2283 or 717-735-6638  
fax: 800-366-1329 or 717-735-6639

#### CCTV Spare Parts

Phone: 800-894-5215 or 408-956-3853 or 3854  
fax: 408-957-3198  
e-mail: BoschCCTVparts@ca.slr.com

#### Canada

Phone: 514-738-2434

#### Europe, Middle East & Asia Pacific Region

Phone: 32-1-440-0711

For additional information, see  
[www.boschsecuritysystems.com](http://www.boschsecuritysystems.com).

## 3 DESCRIPTION

The LTC 8785 Series are control code converters that convert Allegiant® series “variable speed” biphasic control codes into “fixed speed” biphasic control codes.

When AutoDome® pan/tilt/zoom cameras are added to existing Allegiant systems, it is usually preferable to operate them in their variable speed mode. The LTC 8553/00 and LTC 8555/00 keyboards containing proportional joysticks must be added to the system along with an upgrade of the system CPU so the new variable speed control codes can be generated. If the existing system contains older type TC8561 Series receiver/drivers, there will be a code compatibility problem. The older TC8561 Series receiver/drivers were only designed to operate using “fixed speed” control codes and will not function when the newer variable speed codes are being received. To solve this problem, the LTC 8785 Series code converters have been designed to maintain a source of “fixed speed” control codes in this type of system.

The LTC 8785 Series provide 32 separate outputs for driving up to 256 existing TC8561 Series Receiver/Drivers. Either “star” or “daisy chain” wiring configurations may be used. Each output is capable of driving up to 8 receiver/drivers in a “daisy chain” configuration up to 1500 meters (5000 ft) using 1 mm<sup>2</sup> (Belden 8760 or equivalent 18 AWG) shielded twisted pair. A 2 meter (6 ft) data cable for interface to the existing Allegiant LTC 8568/00 Signal Distribution Unit is supplied. The unit will also accept control code supplied from LTC 8569 Series, LTC 8571 Series, or LTC 8572 Series Code Merger units.



## 4 INSTALLATION

### 4.1 Power

Model No. <sup>1</sup>	Rated Voltage	Voltage Range	Power <sup>2</sup>
LTC 8785/60	120 VAC, 50/60 Hz	108 to 132	12 W
LTC 8785/50	220-240 VAC, 50/60 Hz	198 to 264	12 W

<sup>1</sup>These units may be supplied with grounded power cords; grounding should not be defeated.

<sup>2</sup>Nominal power at rated voltage.

### 4.2 Procedure

Refer to ILLUSTRATIONS as necessary per the following instructions.

If possible, install the LTC 8785 Series close enough to the existing LTC 8568/00 Signal Distribution Unit (or LTC 8569 Series Code Merger) so that the supplied 2 meter (6 ft) data cable will reach one of the outputs of the LTC 8568/00 unit. The data output cables corresponding to the older TC8561 Series Receiver/drivers will need to be removed from the existing LTC 8568/00 and connected to the outputs of the LTC 8785 Series. The older LTC 8568/00 mating connector blocks can be connected directly to the connectors on the rear panel of the new LTC 8785 Series. If necessary, the shielded-twisted pair cables can be removed from the older connectors and wired directly to the new connectors.

If these units are placed at a more distant location, the data output cables for the receiver/drivers will need to be extended or re-routed appropriately to the new site.

The data input to the LTC 8785 Series are made to the 9 pin D-connector on the rear panel. The supplied data cable must be prepared so it can be used to connect to an output of the existing LTC 8568/00 Signal Distribution Unit.

- Prepare the data cable by cutting off the end of the cable containing the male 9-pin D-connector.
- Locate the three conductors corresponding to Data + (pin 1), Data - (pin 2), and Shield (pin 3).
- Strip the ends of the three conductors approximately 6 to 7 mm (1/4 in) so they can be connected to one of the output terminal blocks of the existing LTC 8568/00 unit.

- Connect the conductor corresponding to pin 1 to a "+" terminal of the LTC 8568/00 output; pin 2 connects to a "-" output, and pin 3 to a "S" output. If necessary, a shielded-twisted pair cable can be used to extend the data line between an output of the LTC 8568/00 and the input to the LTC 8785 Series.
- Install the AC power cord to the appropriate power source. The POWER LED on the code converter unit's front panel should light when power is applied.

### 4.3 Cover Removal



**WARNING:** Removal of the cover should only be performed by qualified service personnel--not user serviceable. The unit should always be unplugged, before removing the cover and remain unplugged while the cover is removed.

### 4.4 Mounting Options

#### 4.4.1 Rack Mount

The units are supplied from the factory in an enclosure suitable for rack mounting in an EIA 19-inch rack. The enclosure is one EIA standard rack width (19 in) by two rack units high (3 1/2 in). Peel off the four rubber feet located on the bottom of the enclosure before installing it into a console.

#### 4.4.2 Desk Top Mount

If the unit is not going to be rack mounted, the enclosure's mounting ears should be removed. The cover of the unit must be removed before access to the mounting ears is possible. Removal of the cover should only be performed by qualified service personnel. The unit should always be disconnected from the AC power source before removing the cover.

The top cover is fastened to the case by four screws located on the rear of the unit. Once the screws have been removed, the cover slides back and off the unit. Remove each mounting ear by removing the screw holding the mounting ear to the enclosure chassis. See Figure 1.



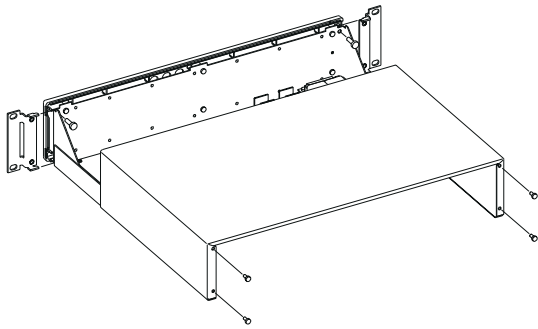

Figure 1 Cover and Rack Ears Removal

## 5 OPERATION

No adjustments or settings within the LTC 8785 Series units are necessary. The CODE LED on the LTC 8785 Series front panel should light when control code is being converted and generated.

## 6 ILLUSTRATIONS



Front Panel

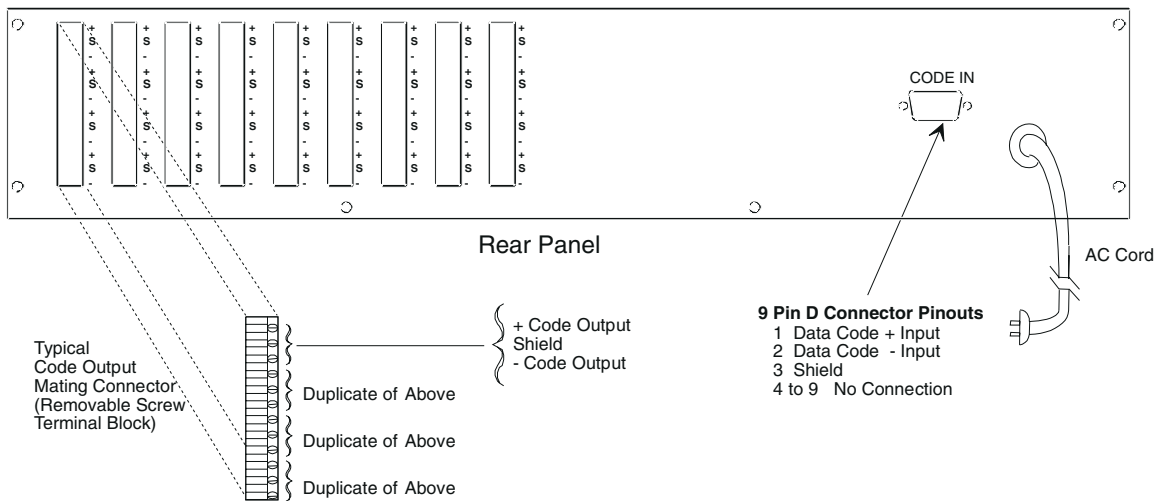

Figure 2 LTC 8785 Series Front and Rear Panel Views

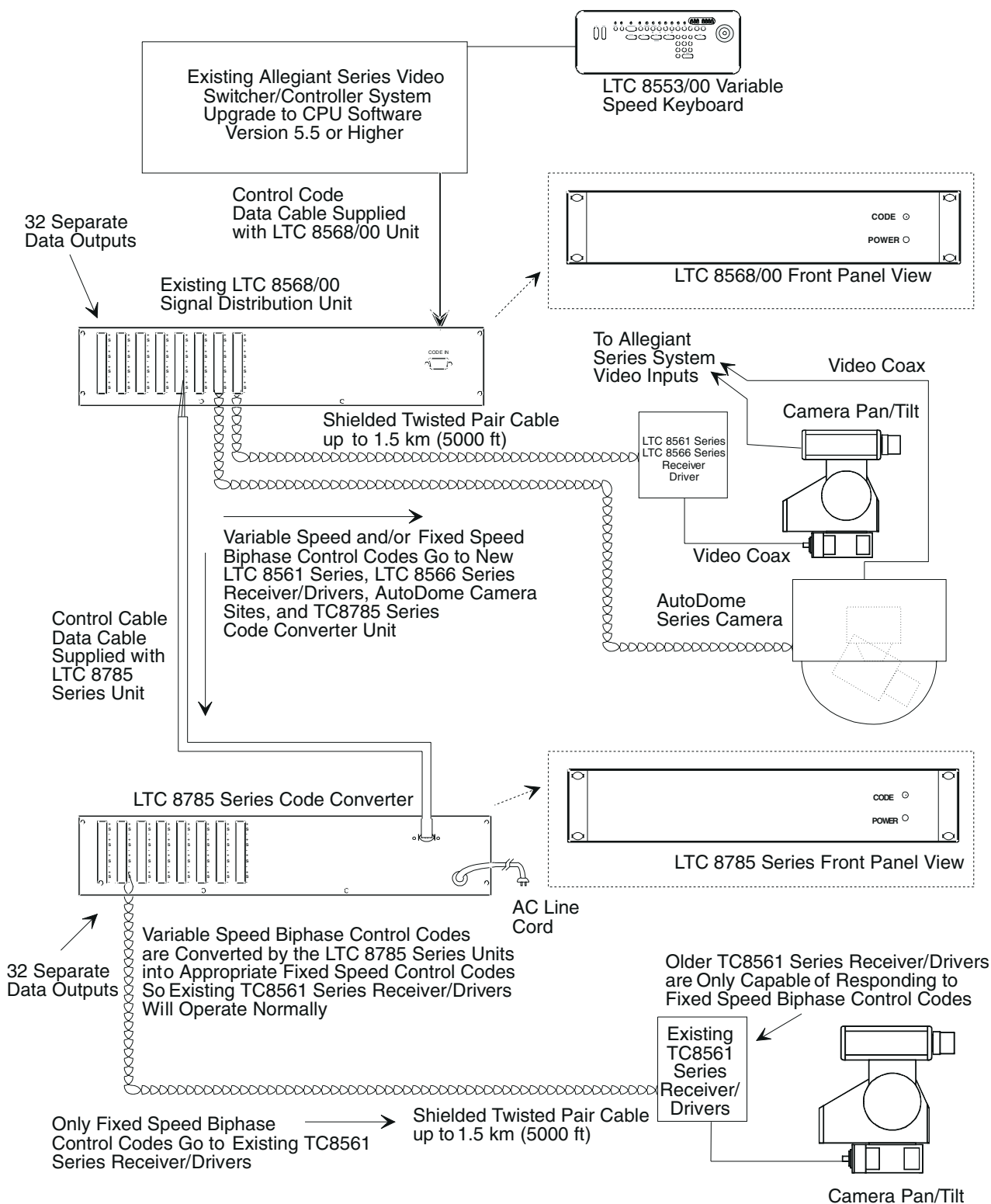

Figure 3 Typical Application Using a LTC 8785 Code Converter Unit



Bosch Security Systems, Inc.  
850 Greenfield Road  
Lancaster, PA 17601 USA  
Tel: 800-326-3270  
Fax: 1-717-735-6560  
[www.boschsecuritysystems.com](http://www.boschsecuritysystems.com)

Bosch Security Systems B.V.  
P.O. Box 80002  
5600 JB Eindhoven  
The Netherlands  
Tele +31 40 27 80000

Bosch Security Systems Pte Ltd.  
38C Jalan Pemimpin  
Singapore 577180  
Republic of Singapore  
Tel: 65 (6) 319 3486

© 2004 Bosch Security Systems GmbH  
3935 890 04412 04-17 | April 19, 2004 | Data subject to change without notice.

**BOSCH**